





The art of illuminating a night time landscape can transform a dark void into a visual wonderland full of texture and contrast.

It's a new world, lit with depth and subtlety, one that appears as the sun goes down and extends the enjoyment of a garden landscape long into the night.

To bring any vision to life you need the right tools.

Aqualux designs and manufactures professional landscape lighting fixtures that will let you realise your landscape lighting vision.



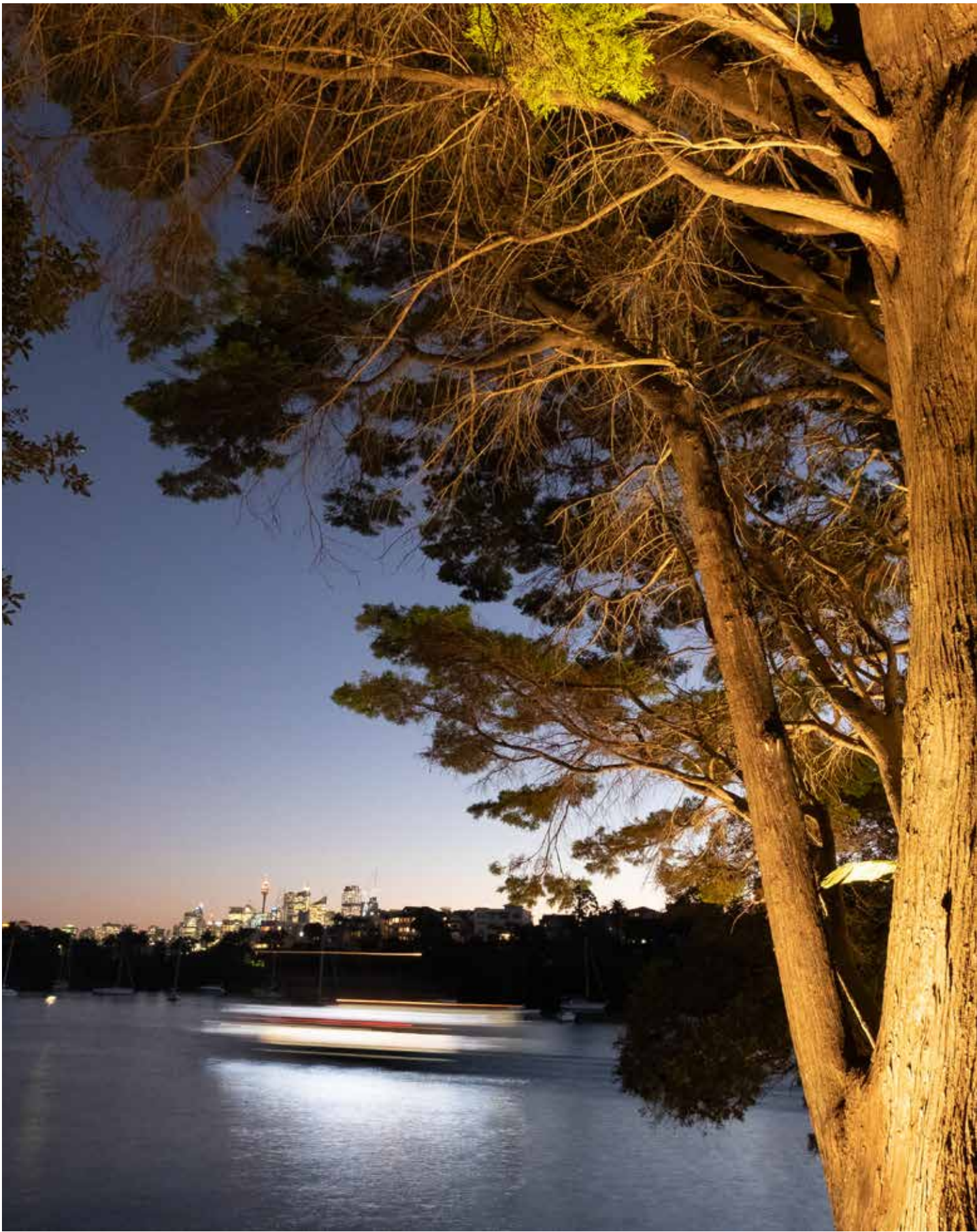

Sydney Ferry, Mosman

AQF-050 / LED Festoon Lighting



Dimmable

Ultra smooth dimming available via PWM and 1-10V DC dimming options. AC dimming also possible.

Ultra Long Runs

Achieve extra long runs and avoid trunking cable requirements with the twin 1.5mm² conductors, with only 1.5V Voltage drop over 100M.

24V AC/DC

Designed to be operated on 24V AC or DC, the AQF-G-001 globe means no mains voltage safety issues and hassle free power supply selection.

Warm White

The 2500K~2800K lamps deliver a warm, pleasing glow that mimics the old incandescent filament globes and creates a candle-glow ambience at night.

Festoon AQF-C-050

Product Code	AQF-050
Lamp Holder	E27 Edison
Lamp Spacing	500mm
Conductor	2 x 1.5mm ²
Cable	Rubber
Warranty	2 Years

Lamp AQF-G-001

Product Code	AQF-G-001
Lamp Base	E27 Edison
Wattage	0.5W / 43lms
Voltage	24V AC or DC
CCT	2700K ~ 2800K
IP	IP40 (IP65 when installed in AQF-050)
Warranty	2 Years

Lamp AQF-G-002

Product Code	AQF-G-002
Lamp Base	E27 Edison
Wattage	0.5W / 43lms
Voltage	24V AC or DC
CCT	2200K ~ 2500K
IP	IP40 (IP65 when installed in AQF-050)
Warranty	2 Years

AQD / 24V DC Power Supplies

The AQD range of IP67 24V DC power supplies

The AQD range is a high performing range of 24V DC power supplies rated to IP67 for use in indoor/outdoor and damp environments. Suitable for LED strip lighting and many other applications where a constant 24V DC voltage is required. Available in 50W, 100W, 200W versions.



Product Code	AQD24-050	AQD24-100	AQD24-200
Watts	50W	100W	200W
Input Voltage	100 - 240V AC 50 / 60 Hz		
Output Voltage	24V DC		
Efficiency	89%	92%	92%
Max Input Current	1A	1.5A	3A
Max Output Current	2.3A	4A	8.3A
IP Rating	IP67		
Approvals	RCM / SAA		
Construction	Epoxy Filled Extruded Aluminium		
Input Cable	1M Flex Lead & Plug (Australian)		
Output Cable	500mm 2 Core		
Operating Temp	-35C ~ 40C		
Max Case Temp (at Tc)	85C (@ 40C Ambient)		
Warranty	5 years		

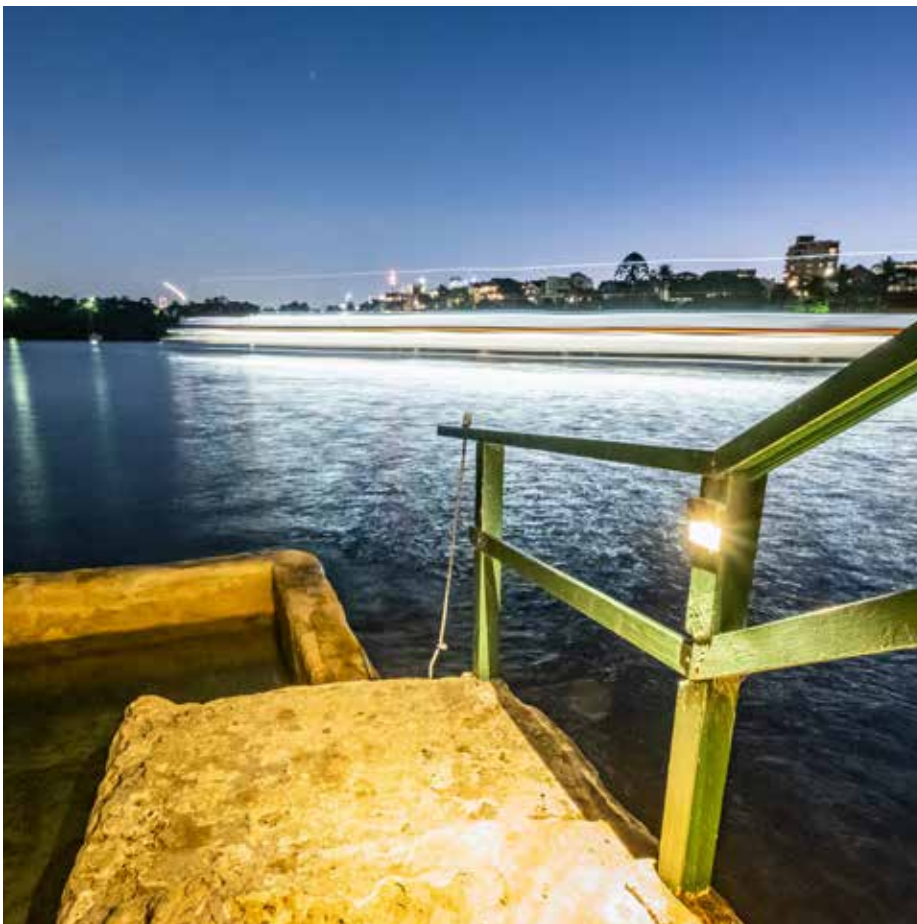

Lumena / CNC Anodised

The Lumena landscape lighting system is a collection of luminaires designed to provide the ultimate in design freedom and quality of workmanship.

Modern landscape design demands modern lighting solutions. Lumena is at the forefront of LED lighting technology, delivering advanced luminaires in compact, minimal designs that feature the latest LED chips and custom developed drivers and control technology.



AQL-195
Micro Deck Light
1W / 100lms



AQL-155
Deck Light
3W 300lms / 6W 550lms



AQL-165
2-Way Runway Light
2W / 100lms



AQL-166
4-Way Runway Light
4W / 200lms



AQL-135
Mini Bollard - Spike
6W / 250lms



AQL-136
Mini Bollard - Surface
6W / 250lms



AQL-105
Fixed Spike Light
3W 300lms / 6W 550lms



AQL-115
Adjustable Spike
3W 300lms / 6W 550lms



AQL-220
Adjustable Spot
3W 300lms / 6W 550lms

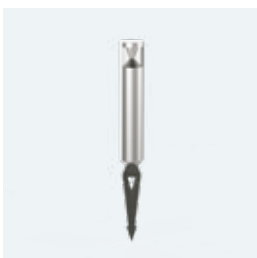

AQL-130
Mini Bollard - Spike
6W / 250lms



AQL-131
Mini Bollard - Surface
6W / 250lms



AQL-175
Puck Light
2W / 200lms



The AQL-158 is a high-power recessed uplight for illuminating walls, features and columns. Available with an advanced wall-washing reflector for even horizontal illumination and glare minimisation, the AQL-158 can also be configured with triple TIR optics for symmetric beam patterns & RGBW operation.



AQL-158
Recessed Uplight 180mm
30W / 2500lms



AQL-180
Projector
25W / 2000lms

The AQL-180 is a high-output projector designed for architectural and commercial lighting applications. Available in White or RGBW options with advanced colour mixing optics, the AQL-180 is perfect for the dynamic RGB illumination of a variety of external facades and features.



Elements / Prism Wall Lights



AQL-600-BK
Prism Wall Down Light
7W 3000K LED



AQL-601-BK
Prism Wall Up/Down Light
14W 3000K LED

The new range of prism wall lights offers elegant simplicity combined with durable construction.

Features include CREE CXA LEDs, high-transmission glass and a choice of 240V or 12/24V SELV power options.



AQL-602-BK
Cube Wall Down Light
7W 3000K LED



AQL-603-BK
Cube Wall Up/Down Light
14W 3000K LED



Elements / Copper & Brass

Landscape lighting essentials that perform to spec and to budget. The Elements range covers many different project requirements from small backyards through to multi-zoned residential developments. Built from quality Copper and Stainless Steel in 304 and 316 grades, Elements has you covered.



AWL-06-CP
Fixed Wall Light
MR16 / GU10 LED Globe



AWL-05-CP
Adjustable Wall Light
MR16 / GU10 LED Globe



AWL-03-CP
Wall Light
MR16 / GU10 LED Globe



AUL-02-CP
Spike Light
MR16 LED Globe

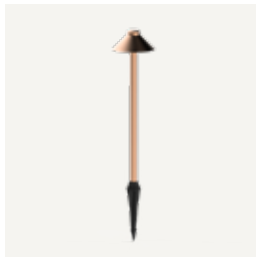

ABL-01-CP-LED
Hooded Pathway Light
6W / 200lm



AUL-04-BR
Inground Up Light / Square
MR16 LED Globe



AUL-03-BR
Inground Up Light / Round
MR16 LED Globe



AWL-06-SS
Fixed Wall Light
MR16 / GU10 LED Globe

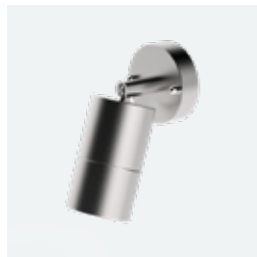

AWL-05-SS
Adjustable Wall Light
MR16 / GU10 LED Globe

Elements / Stainless Steel



AUL-04-SS
Inground Up Light / Square
MR16 LED Globe



AUL-03-SS
Inground Up Light / Round
MR16 LED Globe



AUL-02-SS-BLK
Spike Light / Black
MR16 LED Globe



AUL-02-SS
Spike Light
MR16 LED Globe

Hydra / Aged Brass

The Hydra range is constructed around the best-selling AQL-400-AB spot light. Built using solid cast, aged brass, the Hydra family of outdoor luminaires is a rock-solid platform for creating a dependable and long-lasting landscape lighting solution.

Utilise our class-leading LED lamps for the ultimate in performance and design creativity, allowing you and your clients to develop the perfect landscape lighting project.



AQL-403
Adjustable Surface Spot 38cm
MR16 LED Globe



AQL-416
Hooded Pathway Light
6W / 200lm



AQL-400
Adjustable Spike Spot
MR16 LED Globe



AQL-401
Adjustable Surface Spot
MR16 LED Globe



AQL-405
Surface Mount Path Light
MR16 LED Globe



AQL-413
Single Spot Light - 60cm
MR16 LED Globe



AQL-404
Surface Mount Path Light
MR16 LED Globe



AQL-406
Surface Mount Path Light
MR16 LED Drop In



AQL-407
Twin Path Light 38cm
MR16 LED Globe



AQL-411
Single Spot Light - 38cm
MR16 LED Globe



AQL-412
Single Spot - Elbow
MR16 LED Globe



AQL-402
Twin Spot Light
MR16 LED Globe



AQL-415
Adjustable IP68 Spot Light
MR16 LED Globe



AQL-420
Step Light
Integrated LED 3000K



AQL-418
Step Light
JC-20 / Integrated LED

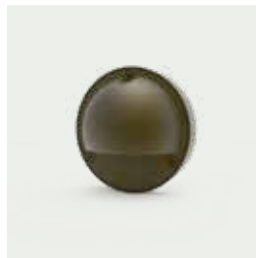

AQL-417
Step Light
Integrated LED 3000K

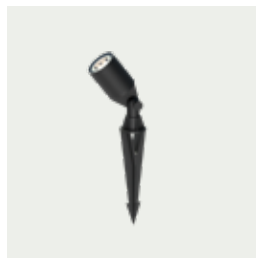

AQL-450
Adjustable IP65 Spike Spot
MR16 LED Globe



AQL-419
Step Light
Integrated LED 3000K





Phoenix / Cast Brass



From one of the oldest classes of metals comes some of the newest lighting products. Phoenix features the latest LED technology and is crafted from 100% solid cast brass, finished in a range of styles to match your next project. Timeless luminaire design for today's landscapes.

Available in Raw Brass, Antique Bronze, Nickle Plate, Black, Copper

AQL-520

Step Light
4W 200lms

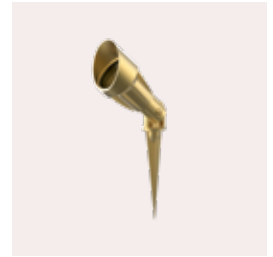
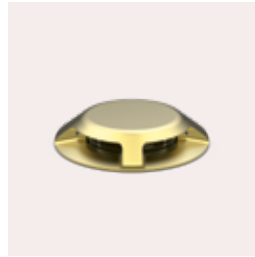

AQL-510

Step Light
4W 200lms

AQL-540

Adjustable Spot Light
4W 300lms / 6W 550lms

AQL-530

Inground Up Light
4W 300lms / 6W 550lms

AQL-565

Surface Grazing Light
6W / 300lms

AQL-503

Adjustable Spike Light
MR16 / 4W 300lms / 6W 550lms



LED Flex



AQS-260

24V AC LED Flex

AQS-400

IP65 Neon Flex 10W

AQS-405

IP65 Neon Flex 5W

AQS-410

IP65 Neon Flex RGB

AQS-500

24V DC LED Flex / IP67

Many more styles and options available. Contact us.

Artisan / Aged Brass



AQA-101-BR
Fixed Up/Down Wall Light
LED MR16 / Integrated



AQA-102-BR
Fixed Wall Light
LED MR16 / Integrated



AQA-103-BR
Adjustable Wall Light
LED MR16 / Integrated



AQA-104-BR
Twin Adjustable Wall Light
LED MR16 / Integrated



AQA-106-BR
Adjustable Spike Light
LED MR16 / Integrated

Artisan / Stainless Steel



AQA-101-SS
Fixed Up/Down Wall Light
LED MR16 / Integrated

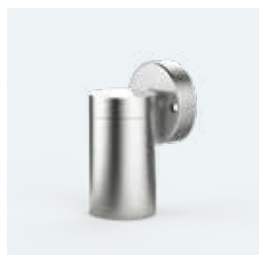

AQA-102-SS
Fixed Wall Light
LED MR16 / Integrated

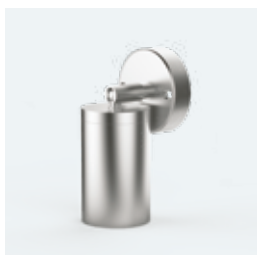

AQA-103-SS
Adjustable Wall Light
LED MR16 / Integrated



AQA-104-SS
Twin Adjustable Wall Light
LED MR16 / Integrated

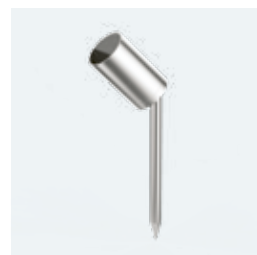

AQA-106-SS
Adjustable Spike Light
LED MR16 / Integrated

Orion / Floodlights



AQL-910
Commercial Floodlight
50W Integrated LED



AQL-910
Commercial Floodlight
100W Integrated LED



AQL-910
RGBW Floodlight
50W Integrated LED



AQL-910
RGBW Floodlight
100W Integrated LED



AQS-500 / Neon Flex IP68



AQS-500 is encapsulated in multiple silicone channels for full IP68 protection. Use for pool copings, in-pavement channels and exterior wall grazing where substantial moisture and mechanical protection is required.

As with all IP68 products, the ingress protection is determined by the quality of the cable joins and installation.

Product Code	AQS-500	AQS-501	AQS-505	AQS-510
Bend Direction	Horizontal	Horizontal	Vertical	Vertical
W / M	12W	5W	10W	10W
lm / M (max)	380lm	160lm	610lm	10W
Dimensions (mm)	11.5x 21	11.5x21	13.5x13.5	16.5x16.5
Mounting	Clips / Profile 1M, 2M			
Construction	Eco-PVC + Encapsulation			
Electrical	24V DC			
Max Run Length	10 M (20M looped)			
Dimming Support	PWM / DALI / DMX			
Min. Bend Radius	40mm	40mm	60mm	60mm
Cut Interval	100 mm	166mm	83mm	50mm
IP Rating	IP68			
IK Rating	IK08			
Warranty	3 Year Aqualux Warranty			
Cable	Various entry styles			

AQS-400 / Neon Flex IP65

Flexible, Silicone Encased IP65 Neon Flex

AQS-400 is a general purpose IP65 rated Neon Flex LED Strip. Smooth, dot-free linear lighting for soft washing of under-bench alcoves, grazing and way-finding applications. Can be used with or without additional aluminium profile. Mounting clips are included and can also be fixed with silicone adhesive.

Product Code	AQS-400	AQS-405	AQS-410
Bend Direction	Vertical	Vertical	Vertical
W / M	10W	5W	10W
lm / M (max)	480lm	200lm	RGB
Dimensions (mm)	10x9	10x9	10x9
Mounting	Clips / Profile 1M, 2M		
Construction	Silicone		
Electrical	24V DC		
Max Run Length	8 M (216 looped)		
Dimming Support	PWM / DALI / DMX		
Min. Bend Radius	30mm		
Cut Interval	30mm		
IP Rating	IP65		
Warranty	3 Year Aqualux Warranty		
Cable	End Entry / Custom Tail Length		



AGL / LED Globes

The only purpose designed landscape lighting LED globes, the Aqualux AGL range is a growing selection of lamps designed to provide a full palette of lighting options for MR16 compatible fittings.



Product Code	CCT / Color	Lumens	Power	Beam
AGL-250-30X38	3000K	250lm	4W	38°
AGL-550-30X36	3000K	550lm	6W	36°
AGL-250-55X38	5500K	250lm	4W	38°
AGL-250-30X60	3000K	235lm	4W	60°
AGL-250-30X10	3000K	235lm	4W	10°
AGL-250-RDX38	Red	627nm	4W	38°
AGL-250-GNX38	Green	530nm	4W	38°
AGL-250-BUX38	Blue	470nm	4W	38°
AGL-250-AMX38	Amber	590nm	4W	38°

- True MR16 Form, fits any MR16 compatible luminaire.
- 3000K / 5700K / Amber / Red / Green / Blue for Lighting design flexibility.
- 12 ~ 24V AC/DC MultiVoltage™ for ultimate installation flexibility.
- Wide 60D model for washing walls, trees and features.
- Ultra-spot 10D model for highlighting columns, trees and features.
- 6W / 550lm version for high-output applications

AQL-450 / Turbo Spike

The AQL-450 "TURBO" Spike is a new adjustable spot light perfect for lighting projects of every budget.

Manufactured from solid cast brass and finished in a durable, textured black powder coat, the AQL-450 is useful wherever a spike spot is needed.

The included Aqualux 4W LED globe comes pre-installed allowing rapid installation and setup.

- **Solid Brass**
- **5yr Warranty**
- **Black Powder Coat**
- **4W MR16 LED Included**
- **250lm, 3000K, 12~24V AC/DC**

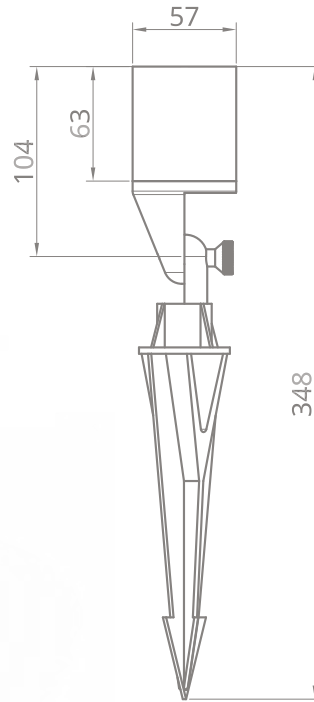
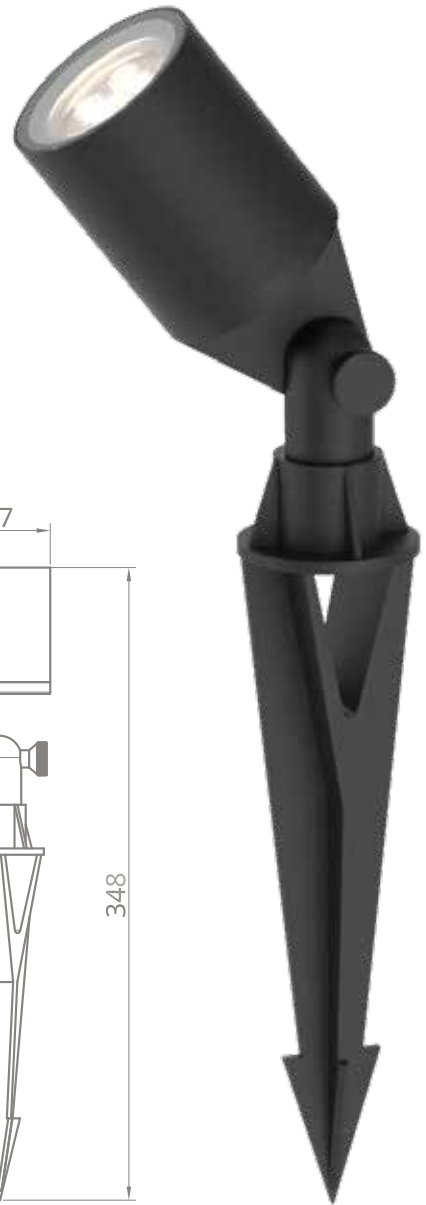



1300 662 644

sales@aqualux.com.au

Visit www.aqualux.com.au for:

Full product details and available options.

Order code configuration & customised datasheets.

Voltage drop calculator & LED technical information.

